

fluimac[®]
pump solution



PHOENIX

AIR-OPERATED DOUBLE DIAPHRAGM PUMPS

Made in
Italy

www.fluimac.com

ENGLISH 

fluimac
pump solution



MAIN FEATURES

Fluimac is an original, young and dynamic company built in 2012 for a new concept of product. It is specialized in providing pump solutions with an innovative and continuously developing design of range. The huge experience, knowledge and efficiency of its team is the starting point of its own business. Fluimac stands out for its reliable and prompt technical support and assistance. The internal research and development department ensures the proficiency of its team, which constantly grows in order to satisfy all the customers' needs. The company keeps up with the constant evolution of the national and international market and its quality control guarantees innovative and certificated products, which respect current legal standards. The organization of the warehouse and the assembly/testing department, allows the company to offer short delivery times, immediate check of availability, speedy shipments and fast service assistance. The policy of Fluimac relies also on excellent customer service and a network of efficient, reliable distributors who ensure willingness, quality and technical support. This makes Fluimac a high quality company, grounded in excellence.

FLUIMAC'S CERTIFICATES



CE CONFORMITY MARKING



ATEX



ISO 9001:2015

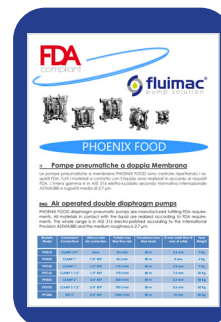

FDA COMPLIANT



EAC CONFORMITY MARKING

PRODUCTS	RANGE	CERTIFICATES
<p>Air operated double diaphragm pumps have long been recognized as the most flexible pumps of the industry for handling difficult liquids at relatively low pressures and flows. The range of applications is virtually limitless. Flumac AODD pumps come in many sizes and choices of materials of construction. Almost every type of liquid from highly corrosive acids through high viscosity paints and adhesives, to food and drink products can be pumped.</p>	 <p>PHOENIX Air operated double diaphragm pumps Realized in: PP, PVDF, ALUMINIUM, SS AISI 316, POMc Flow-rate from 7 lt/min to 1.000 lt/min. Connection from 1/4" to 3".</p>	
	 <p>PHOENIX FOOD Air operated double diaphragms pumps Realized in: SS AISI 316 electro-polished. Flow-rate from 20 lt/min to 1.000 lt/min. Tri-Clamp Connection.</p>	
	 <p>PHOENIX ATEX Air operated double diaphragms pumps, ATEX certified for zone1. Realized in: PP+CF, PVDF+CF, ALUMINIUM, SS AISI 316, POMc+CF Flow-rate from 7 lt/min to 1.000 lt/min. Connection from 1/4" to 3".</p>	
	 <p>ACCURATE PHOENIX Double diaphragm pumps with remote control Realized in: PP, PVDF, ALUMINIUM, SS AISI 316, POMc Flow-rate from 7 lt/min to 250 lt/min. Connection from 1/4" to 1 1/4".</p>	
	 <p>DRUM PHOENIX Air operated double diaphragms pumps with special features to empty drums and tanks Realized in: PP, PVDF, ALUMINIUM, SS AISI 316, POMc Flow-rate from 20 lt/min to 170 lt/min. Connection from 3/8" to 1".</p>	
	 <p>TWIN PHOENIX Air operated double diaphragms pumps with special features with double inlet/outlet Realized in: PP, PVDF, ALUMINIUM, SS AISI 316, POMc Flow-rate from 7 lt/min to 700 lt/min. Connection from 1/4" to 2".</p>	
	 <p>SUBMERSIBLE PHOENIX Air operated double diaphragm pumps with special features, design to be submerged. Applicable to all size of pumps.</p>	
	 <p>POWDER PHOENIX Air operated double diaphragms pump with special design to handle powder Realized in: ALU, SS. Size available 1 1/2 and 2".</p>	
	 <p>DAMPER Pneumatic, automatic pulsation dampeners. Realized in: PP, PVDF, ALUMINIUM, SS AISI 316, POMc Applicable to all size of pumps. Available also in ATEX and FOOD version.</p>	

TECHNICAL FEATURES

Wide Range of sizes and materials suited to variety of conditions and chemicals fluids

Safely "dead head" function, against closed discharge, without pump damage

Dry-run without damaging the pump or system: seal-less design

Handled liquids with solids particles: ideal for abrasive and viscous media

Self-priming dry up to 6 meters: works in suction lift applications

Fully submersible: can be submerged completely according to the fluid compatibility

Efficient performance: high flow rates through optimal casings designs

Serviceability: easily and quickly maintained without any special tools

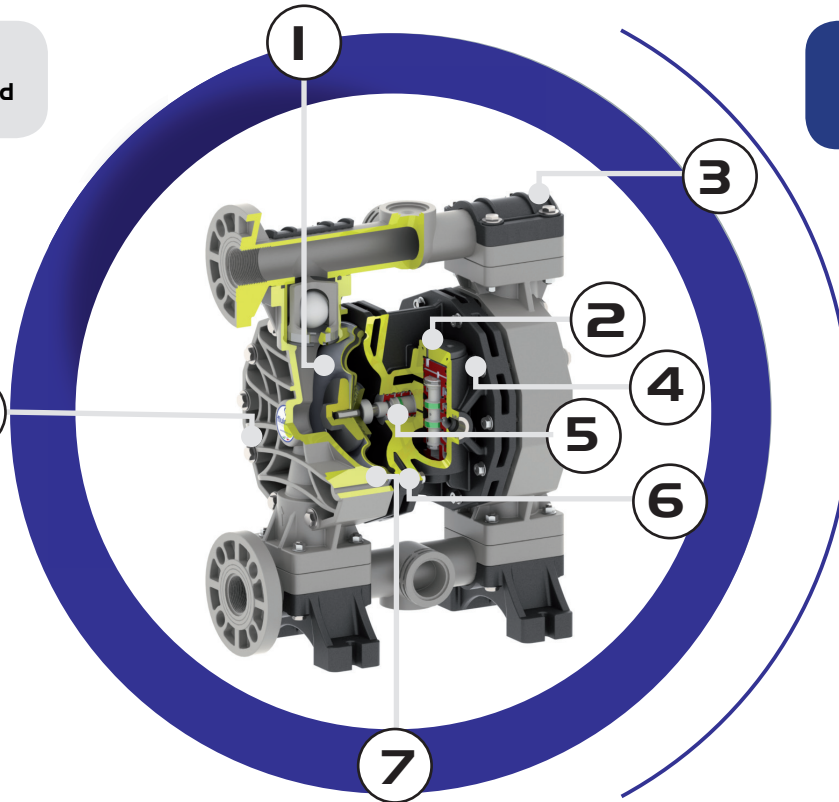

1 2 3 4 5 6 7 8

<p>Long-lasting diaphragm construction ensures a consistent performance and a longer operating life.</p>	<p>Efficient air distribution design: low air consumption. Un-balanced pilot spool, precisely controls positioning of the main power spool to eliminate stalling and increase efficiency.</p>	<p>All bolted design for an effective sealing to extended leak-proof service.</p>	<p>Solid polypropylene air chambers and plastic air valve for maximum chemical resistance in highly corrosive environments.</p>	<p>Acetalic shuttle ensures long valve life, auto-lubricated material.</p>	<p>Pneumatic exchanger is easily externally accessible for a quick inspection. Special Air system: lube-free, non-stall, non-freeze.</p>	<p>Special pinch clamping, design to minimize wear and increase life of the diaphragm, and provides a uniform seal to avoid leak.</p>	<p>Special exhaust chamber with double silencer to expand diffusion passages, reduce the icing and assure low noise level.</p>
--	---	---	---	--	--	---	--

QUALITY 100% wet tested after final assembly: deadheading, priming and sealing

SAFE ATEX certifications in all versions: Conductive plastic pumps available

FLEXIBILITY Multiple porting options available along with interface options

PUMP OPERATION



Suction Cycle

1

Compressed air fills right inner chamber, causing the opposing diaphragm to create suction, lifting the lower valve ball, pulling in fluid at inlet. Simultaneously, the right chamber is in "Discharge" cycle.

Discharge Cycle

2

Compressed air fills left inner chamber, causing upper valve ball to open and discharge fluid. Simultaneously, the right chamber is in "Suction" cycle.

INSTALLATION



Pump installed below head (positive suction)

when it is necessary to empty completely the container



Self priming pump installed above head (negative suction)

pump initially works with dry column without problem



Pump installed above drum or tank

with special featuring pump

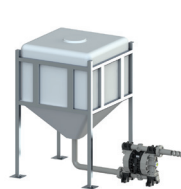

Pump installed on hopper for high viscosity liquid

hopper's height helps the pump to treat the fluid. Air pressure has to be high, Suction tube has to be bigger than pump's size

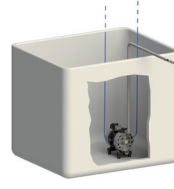

Submerged pump

it is necessary to check the chemical compatibility



Suspended

special version with fixing feet also in the upper part, for ceiling fixing



Pump installed on a mobile unit

with a trolley or cart when pump must be often moved

P

0160

P-

HT

T

MODEL

SIZE

CASING

DIAPHRAGM

BALL

P
PHOENIX



7 - 7 lt/min

18 - 20 lt/min

30 - 35 lt/min

55 - 55 lt/min

60 - 65 lt/min

90 - 100 lt/min

120 - 120 lt/min

170 - 170 lt/min

252 - 250 lt/min

400 - 380 lt/min

700 - 700 lt/min

1000 - 1050 lt/min

PF
PHOENIX FOOD



AP
ACCURATE
PHOENIX



TP
TWIN PHOENIX



PP
POWDER PHOENIX



SP
SUBMERSIBLE
PHOENIX

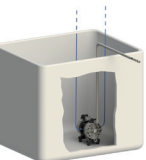

P
POLYPROPYLENE
Wide chemical compatibility. General purpose. Reinforced with glass-fiber.



PC
CONDUCTIVE POLYPROPYLENE
Wide chemical compatibility. General purpose. Groundable.



KC
CONDUCTIVE PVDF
Strong chemical resistance to acids. High temperature resistance. Groundable.

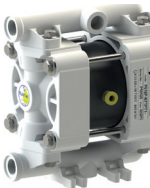

O
ACETAL
Wide range of solvent and hydrocarbons resistance. Good level of abrasion resistance.



OC
CONDUCTIVE ACETAL
Wide range of solvent and hydrocarbons. Good level of abrasion resistance. Groundable.



A
ALUMINIUM
Wide range of solvent and hydrocarbons. Good level of abrasion resistance.



S
SS AISI 316
High level of corrosion and abrasion resistance.

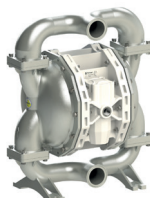

S
SS - AISI 316 Electropolished
High level of corrosion and abrasion resistance. Phoenix Food.



N
NBR
Good for petroleum-based fluids, water, oils, hydrocarbons and MILD chemicals



D
EPDM
Good with caustic solutions, dilute acids, ketones and alcohols. Good abrasion resistance



T
PTFE
Widest chemical compatibility, extreme corrosion resistance, non-adhesive, high heat resistance.



H
HYTREL
Good low temperature properties. Good abrasion resistance.



M
SANTOPRENE
solutions and dilute acids.



N
NBR
Good for petroleum-based fluids, water, oils, hydrocarbons and MILD chemicals



D
EPDM
Good with caustic solutions, dilute acids, ketones and alcohols. Good abrasion resistance



T
PTFE
Widest chemical compatibility, extreme corrosion resistance, non-adhesive, high heat resistance.



S
SS
High level of corrosion and abrasion resistance. Good for viscous fluids.

P

V

1

-

AB

BALL SEAT

GASKET

CONNECTIONS

ATEX ZONE CERTIFICATION

PORTS



P
POLYPROPYLENE
Wide chemical compatibility. General purpose.



K
PVDF
Strong chemical resistance to acids. High temperature resistance.



A
ALUMINIUM
Wide range of solvent and hydrocarbons. Good level of abrasion resistance.



S
SS
High level of corrosion and abrasion resistance.



Z
PE
With high molecular weight: High level of abrasion resistance



O
ACETAL
Wide range of solvent and hydrocarbons resistance. Good level of abrasion resistance.



V
VITON
High heat resistance. Good resistance to aggressive chemicals and hydrocarbons.



N
NBR
Good for petroleum-based fluids, water, oils, hydrocarbons and MILD chemicals.



D
EPDM
Good with caustic solutions, dilute acids, ketones and alcohols. Good abrasion resistance.



T
PTFE
Widest chemical compatibility, extreme corrosion resistance, non-adhesive, high heat resistance.

1
BSP THREADED

2
FLANGED

3
TRI-CLAMP
(PHOENIX FOOD)

5
NPT THREADED

6 - DIN 11851/3
(PHOENIX FOOD)



-
ATEX ZONE 2

II 3/3 G Ex h IIB T4 Gc
II -/3 D Ex h IIIB T135°C Dc X

X
ATEX ZONE 1

II 2/2 G Ex h IIB T4 Gb
II -/2 D Ex h IIIB T135°C Db X

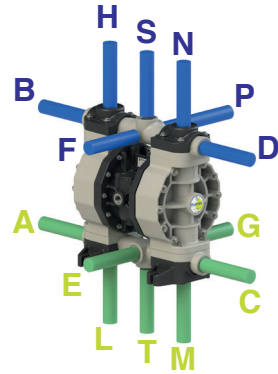

TABLE CODE

PUMP SELECTION

To select the right FLUIMAC pump for your application, the following factors should be considered to achieve economy of operation, long pump life, and minimal maintenance costs:

- The nature of the medium to be pumped, its viscosity, and the solids content
- Pumping capacity in relation to the desired output
- Suction and pressure conditions

Considering these parameters, an optimal pump size is selected when the intersection of the intended installation “pressure vs. flow rate” is near the middle section of the curves.

USING PERFORMANCE CURVES

To determine compressed air requirements and proper size for a FLUIMAC AODD pump, two elements of information are required:

- 1 Required Flow Rate
- 2 Total Delivery Head

As an example, consider a P170 pump performance curve, pumping about 135 lt/min at 25m. Point A on the performance curve is where the desired Flow Rate and Total Delivery Head points intersect. This point determines compressed air requirements for the particular pump. At performance point A, the pump will require approximately 7 bar air inlet pressure. To arrive at this figure, follow the solid blue curve to the left to read the air pressure rating in BAR. By looking at the nearest green curve, it is determined the pump will require approximately 900 nl/min (Normal Liter per minute) of air consumption.

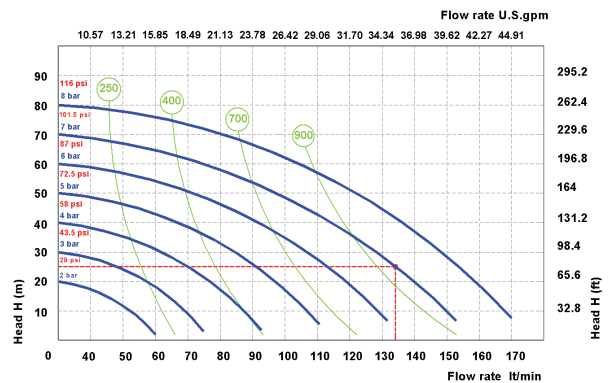

SPECIFIED SUCTION LIFT

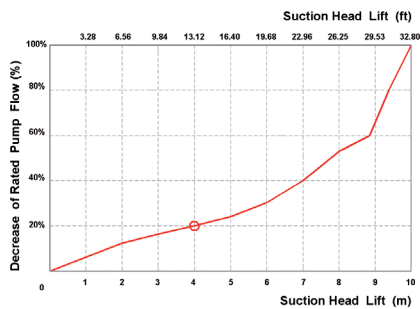

With a suction lift of 4 m, pump rate decreases by approximately 20%. Valid for pumps 3/4” and larger; data varies with pump configuration.

VISCOUS LIQUIDS PERFORMANCE DATA

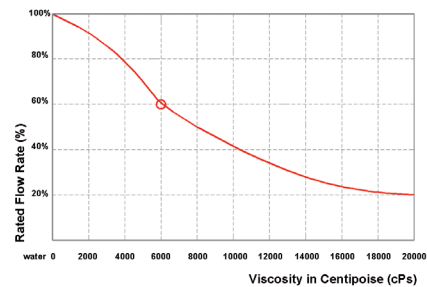

During the conveyance of a fluid with a viscosity of 6000cPs, the pump rate decreases to 60% of its rated value (100% = water). Valid for 3/4” pumps & larger.

PUMP TYPE	AODD	CENTRIFUGAL	LOBE	GEAR	SCREW	PERISTALTIC	PISTON
Variable Flow & Head Control	✓	✓	✓	✓	!	✓	✓
Deadhead Safely	✓	!	!	!	!	!	!
Dry-Running	✓	✗	✗	✗	✗	✓	✗
Dry Self-Priming	✓	✗	✗	✓	✗	✓	!
No Mechanical Alignment	✓	✗	✗	✗	✗	✗	✗
No Electrical Installation	✓	✗	✗	✗	✗	✗	✗
Portability	✓	✓	!	!	!	✓	!
Submersible	✓	!	✗	✗	✗	✗	!
Sealless	✓	!	!	!	!	!	!
Cavitation Tolerance	✓	✗	!	!	✓	✓	!
Low Shear & Degradation	✓	✗	✓	✓	!	✓	!

✓ = Suitable ! = Limitations ✗ = Not Recommended



fluimac
pump solution



PHOENIX

Realized in:

PP, PVDF, ALUMINIUM, SS AISI 316, POMc

Flow-rate from 7 lt/min to 1.000 lt/min

Connection from 1/4" to 3".

ATEX certification for zone 2

 II 3/3 G Ex h IIB T4 Gc

 II -/3 D Ex h IIB T135°C Dc X



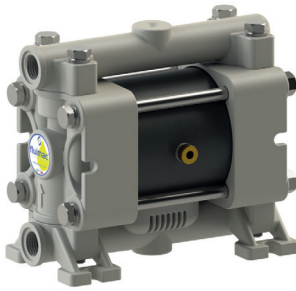

PP



PVDF+CF

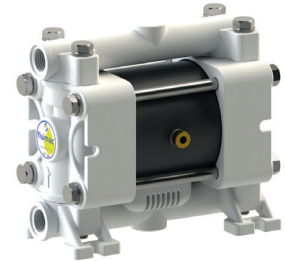

POMc

TECHNICAL DATA

Fluid connections	1/4" BSP
Air connection	4 mm
Max. Flow rate	7 lt/min
Max air pressure	6 bar
Max delivery head	60 m
Max Suction Lift Dry	3 m
Max Suction Lift Wet	9,8 m
Max Solid passing	2 mm
Noise level:	62 dB
Max Viscosity:	5.000 cps
Displacement per Stroke:	18 CC ~

Ex II 3/3 G Ex h IIB T4 Gc
Ex II -/3 D Ex h IIB T135°C Dc X

Displacement per stroke may vary based on suction condition, discharge head, air pressure and fluid type.

PERFORMANCE

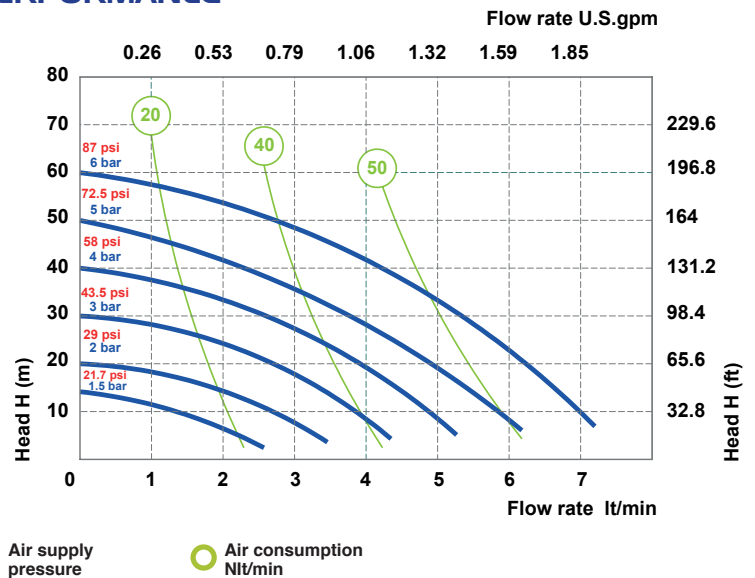

The curves and performance values refer to pumps with submerged suction and free delivery outlet, with water at 20°C. These data may vary according to the construction materials and hydraulic conditions.

DIMENSIONS

	A	B	C	Net Weight	Temperature
PP	129 mm	68 mm	112 mm	0,84 Kg	- 4°C + 65°C
PVDF	129 mm	68 mm	112 mm	0,96 Kg	- 20°C + 95°C
POMc	129 mm	68 mm	112 mm	0,84 Kg	- 5°C + 80°C

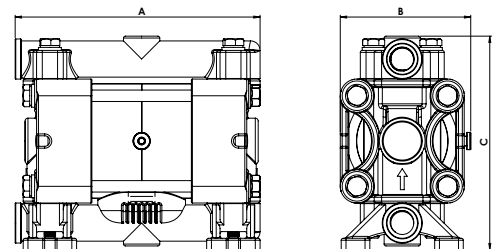

COMPOSITION

MODEL	CASING	DIAPHRAGM	BALLS	SEATS	GASKET	CONNECTIONS	ATEX	PORTS
P0007	P = PP KC = PVDF+CF O = POMc	NT = NBR+PTFE	T = PTFE S = SS	P = PP K = PVDF O = POMc	D = EPDM V = VITON N = NBR T = PTFE	1 = BSP 5 = NPT	- = zone 2	AB = STANDARD

P 18



PP



PVDF+CF

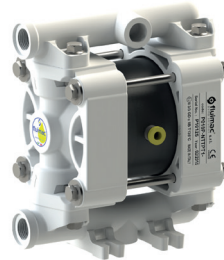

POMc



SS

TECHNICAL DATA

Fluid connections	3/8" BSP
Air connection	6 mm
Max. Flow rate	20 lt/min
Max air pressure	7 bar
Max delivery head	70 m
Max Suction Lift Dry	5 m
Max Suction Lift Wet	9,8 m
Max Solid passing	2,5 mm
Noise level:	65 dB
Max Viscosity:	10.000 cps
Displacement per Stroke:	30 CC ~

Ex II 3/3 G Ex h IIB T4 Gc
Ex II -/3 D Ex h IIB T135°C Dc X

Displacement per stroke may vary based on suction condition, discharge head, air pressure and fluid type.

PERFORMANCE

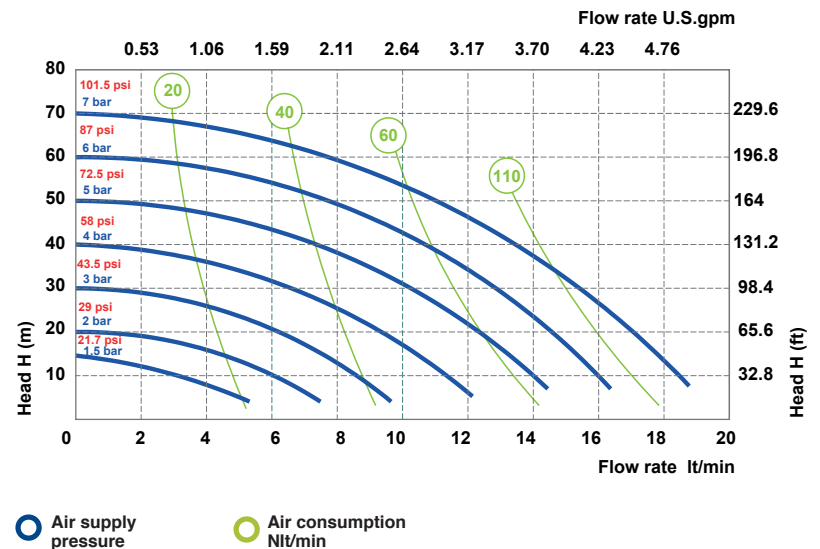

○ Air supply pressure ○ Air consumption Nlt/min

The curves and performance values refer to pumps with submerged suction and free delivery outlet, with water at 20°C. These data may vary according to the construction materials and hydraulic conditions.

DIMENSIONS

	A	B	C	Net Weight	Temperature
PP	146 mm	96 mm	167 mm	1,3 Kg	- 4°C + 65°C
PVDF	146 mm	96 mm	167 mm	1,6 Kg	- 20°C + 95°C
POMc	146 mm	96 mm	167 mm	1,5 Kg	- 5°C + 80°C
SS	148 mm	92 mm	152 mm	2,3 Kg	- 20°C + 95°C

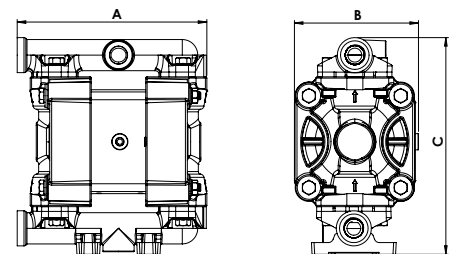

COMPOSITION

MODEL	CASING	DIAPHRAGM	BALLS	SEATS	GASKET	CONNECTIONS	ATEX	PORTS
P0018	P = PP KC = PVDF+CF O = POMc SS = SS	HT = HYTREL+PTFE MT = SANTOPRENE+PTFE H = HYTREL M = SANTOPRENE	T = PTFE S = SS	P = PP K = PVDF O = POMc S = SS	D = EPDM V = VITON N = NBR T = PTFE	1 = BSP 5 = NPT	- = zone 2	AB = STANDARD

P 30



PP



PVDF+CF



ALU



SS

TECHNICAL DATA

Fluid connections	1/2" BSP
Air connection	6 mm
Max. Flow rate	35 lt/min
Max air pressure	7 bar
Max delivery head	70 m
Max Suction Lift Dry	5 m
Max Suction Lift Wet	9,8 m
Max Solid passing	3 mm
Noise level:	65 dB
Max Viscosity:	15.000 cps
Displacement per Stroke:	65 CC ~

Ex II 3/3 G Ex h IIB T4 Gc
Ex II -/3 D Ex h IIB T135°C Dc X

Displacement per stroke may vary based on suction condition, discharge head, air pressure and fluid type.

PERFORMANCE

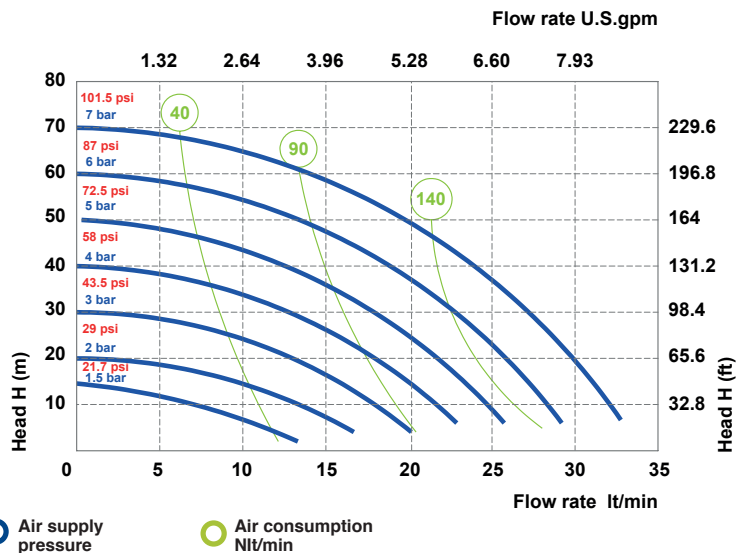

The curves and performance values refer to pumps with submerged suction and free delivery outlet, with water at 20°C. These data may vary according to the construction materials and hydraulic conditions.

DIMENSIONS

	A	B	C	Net Weight	Temperature
PP	177 mm	105 mm	185 mm	1,8 Kg	- 4°C + 65°C
PVDF	177 mm	105 mm	185 mm	2,3 Kg	- 20°C + 95°C
ALU	183 mm	110 mm	189 mm	2,8 Kg	- 20°C + 95°C
SS	181 mm	106 mm	192 mm	3,8 Kg	- 20°C + 95°C

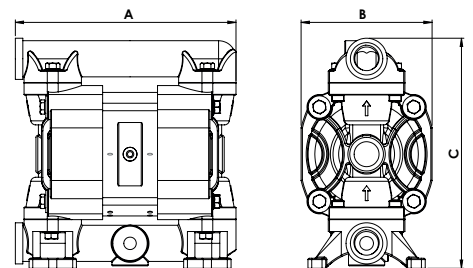

COMPOSITION

MODEL	CASING	DIAPHRAGM	BALLS	SEATS	GASKET	CONNECTIONS	ATEX	PORTS
P0030	P = PP	HT = HYTREL+PTFE	T = PTFE	P = PP	D = EPDM	1 = BSP	- = zone 2	AB = STANDARD
	KC = PVDF+CF	MT = SANTOPRENE+PTFE	S = SS	K = PVDF	V = VITON	2 = FLANGED		
	S = SS	H = HYTREL	D = EPDM	S = SS	N = NBR	5 = NPT		
	A = ALU	M = SANTOPRENE	N = NBR	Z = PE-UHMWE	T = PTFE			

P 55



PP



PVDF+CF



ALU



SS

TECHNICAL DATA

Fluid connections	1/2" BSP
Air connection	1/4" BSP
Max. Flow rate	55 lt/min
Max air pressure	8 bar
Max delivery head	80 m
Max Suction Lift Dry	5 m
Max Suction Lift Wet	9,8 m
Max Solid passing	3,5 mm
Noise level:	70 dB
Max Viscosity:	20.000 cps
Displacement per Stroke:	140 CC ~

Ex II 3/3 G Ex h IIB T4 Gc
Ex II -/3 D Ex h IIB T135°C Dc X

Displacement per stroke may vary based on suction condition, discharge head, air pressure and fluid type.

PERFORMANCE

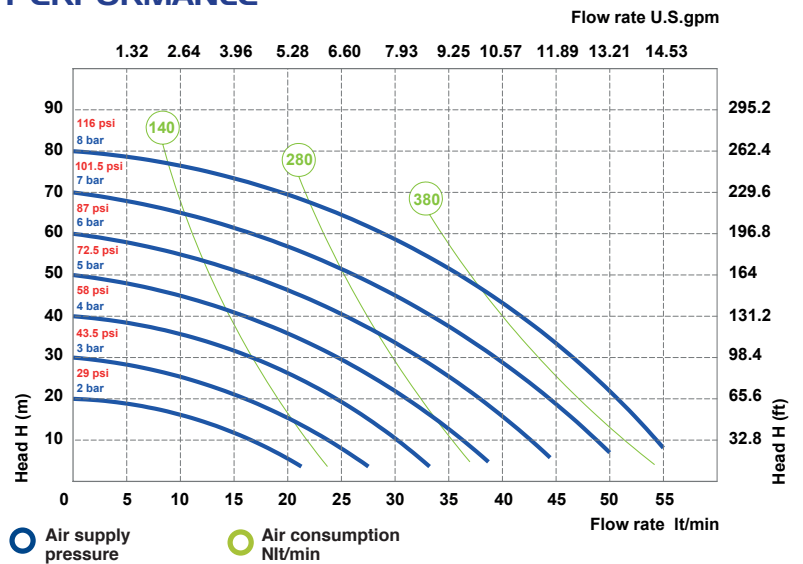

The curves and performance values refer to pumps with submerged suction and free delivery outlet, with water at 20°C. These data may vary according to the construction materials and hydraulic conditions.

DIMENSIONS

	A	B	C	Net Weight	Temperature
PP	238 mm	156 mm	249 mm	3,8 Kg	- 4°C + 65°C
PVDF	238 mm	156 mm	249 mm	4,8 Kg	- 20°C + 95°C
ALU	234 mm	156 mm	245 mm	3,8 Kg	- 20°C + 95°C
SS	234 mm	156 mm	268 mm	6,8 Kg	- 20°C + 95°C

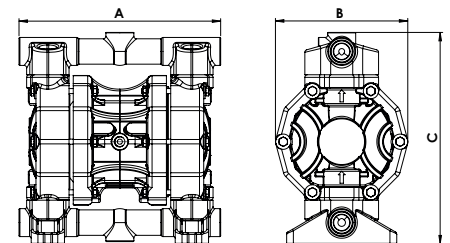

COMPOSITION

MODEL	CASING	DIAPHRAGM	BALLS	SEATS	GASKET	CONNECTIONS	ATEX	PORTS
P0055	P = PP	HT = HYTREL+PTFE	T = PTFE	P = PP	D = EPDM	1 = BSP	- = zone 2	AB = STANDARD
	KC = PVDF+CF	MT = SANTOPRENE+PTFE	S = SS	K = PVDF	V = VITON	2 = FLANGED		
	S = SS	H = HYTREL	D = EPDM	S = SS	N = NBR	5 = NPT		
	A = ALU	M = SANTOPRENE	N = NBR	Z = PE-UHMWE	T = PTFE			

P 60



PP



PVDF+CF



ALU



SS

TECHNICAL DATA

Fluid connections	1/2" BSP
Air connection	1/4" BSP
Max. Flow rate	65 lt/min
Max air pressure	8 bar
Max delivery head	80 m
Max Suction Lift Dry	5 m
Max Suction Lift Wet	9,8 m
Max Solid passing	3,5 mm
Noise level:	72 dB
Max Viscosity:	20.000 cps
Displacement per Stroke:	140 CC ~

Ex II 3/3 G Ex h IIB T4 Gc
Ex II -/3 D Ex h IIIB T135°C Dc X

Displacement per stroke may vary based on suction condition, discharge head, air pressure and fluid type.

PERFORMANCE

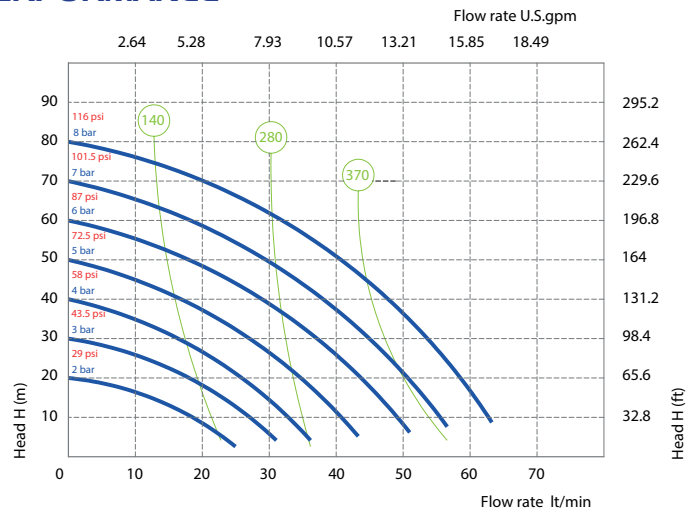

The curves and performance values refer to pumps with submerged suction and free delivery outlet, with water at 20°C. These data may vary according to the construction materials and hydraulic conditions.

DIMENSIONS

	A	B	C	Net Weight	Temperature
PP	238 mm	165 mm	249 mm	4,3 Kg	- 4°C + 65°C
PVDF	238 mm	165 mm	249 mm	5,3 Kg	- 20°C + 95°C
ALU	234 mm	165 mm	245 mm	4,3 Kg	- 20°C + 95°C
SS	234 mm	165 mm	268 mm	7,3 Kg	- 20°C + 95°C

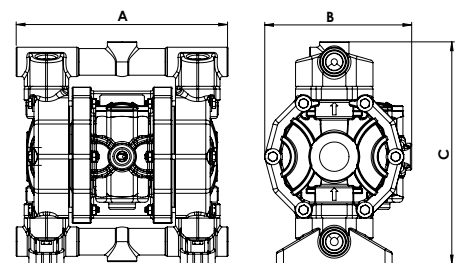

COMPOSITION

MODEL	CASING	DIAPHRAGM	BALLS	SEATS	GASKET	CONNECTIONS	ATEX	PORTS
P0060	P = PP	HT = HYTREL+PTFE	T = PTFE	P = PP	D = EPDM	1 = BSP	- = zone 2	AB = STANDARD
	KC = PVDF+CF	MT = SANTOPRENE+PTFE	S = SS	K = PVDF	V = VITON	2 = FLANGED		
	S = SS	H = HYTREL	D = EPDM	S = SS	N = NBR	5 = NPT		
	A = ALU	M = SANTOPRENE	N = NBR	Z = PE-UHMWE	T = PTFE			
		D = EPDM		A = ALU				
		N = NBR						

P 90

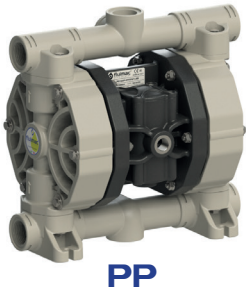

PP



PVDF+CF



ALU (P 100)



SS (P 100)

TECHNICAL DATA

Fluid connections	3/4" BSP
Air connection	3/8" BSP
Max. Flow rate	100 lt/mm
Max air pressure	8 bar
Max delivery head	80 m
Max Suction Lift Dry	5 m
Max Suction Lift Wet	9,8 m
Max Solid passing	4 mm
Noise level:	72 dB
Max Viscosity:	15.000 cps
Displacement per Stroke:	200 CC ~

Ex II 3/3 G Ex h IIB T4 Gc
Ex II -/3 D Ex h IIIB T135°C Dc X

Displacement per stroke may vary based on suction condition, discharge head, air pressure and fluid type.

PERFORMANCE

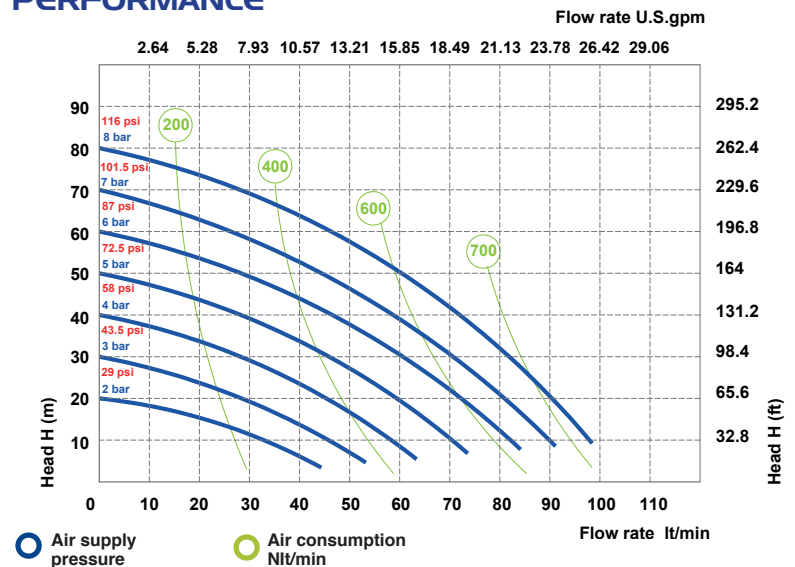

The curves and performance values refer to pumps with submerged suction and free delivery outlet, with water at 20°C. These data may vary according to the construction materials and hydraulic conditions.

DIMENSIONS

	A	B	C	Net Weight	Temperature
PP	293 mm	176 mm	280 mm	5,1 Kg	- 4°C + 65°C
PVDF	293 mm	176 mm	280 mm	6,6 Kg	- 20°C + 95°C
ALU	265 mm	178 mm	245 mm	5,6 Kg	- 20°C + 95°C
SS	247 mm	178 mm	251 mm	7,6 Kg	- 20°C + 95°C

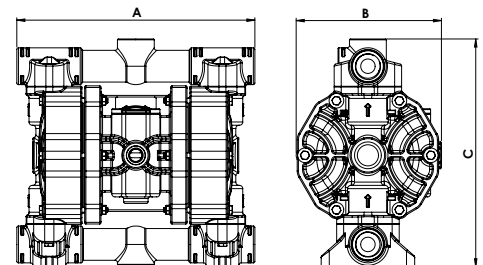

COMPOSITION

MODEL	CASING	DIAPHRAGM	BALLS	SEATS	GASKET	CONNECTIONS	ATEX	PORTS
P0090	P = PP	HT = HYTREL+PTFE	T = PTFE	P = PP	D = EPDM	1 = BSP		
P0100	KC = PVDF+CF	MT = SANTOPRENE+PTFE	S = SS	K = PVDF	V = VITON	2 = FLANGED	- = zone 2	AB = STANDARD
	S = SS	H = HYTREL	D = EPDM	S = SS	N = NBR	5 = NPT		
	A = ALU	M = SANTOPRENE	N = NBR	Z = PE-UHMWE	T = PTFE			
		D = EPDM		A = ALU				
		N = NBR						

P 120

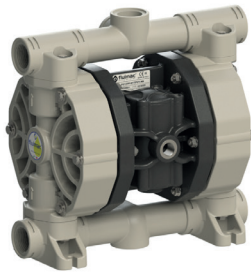

PP



PVDF+CF



SS

TECHNICAL DATA

Fluid connections	1" BSP
Air connection	3/8" BSP
Max. Flow rate	120 lt/mm
Max air pressure	8 bar
Max delivery head	80 m
Max Suction Lift Dry	5 m
Max Suction Lift Wet	9,8 m
Max Solid passing	4 mm
Noise level:	72 dB
Max Viscosity:	25.000 cps
Displacement per Stroke:	200 CC ~

Ex II 3/3 G Ex h IIB T4 Gc
Ex II -/3 D Ex h IIIB T135°C Dc X

Displacement per stroke may vary based on suction condition, discharge head, air pressure and fluid type.

PERFORMANCE

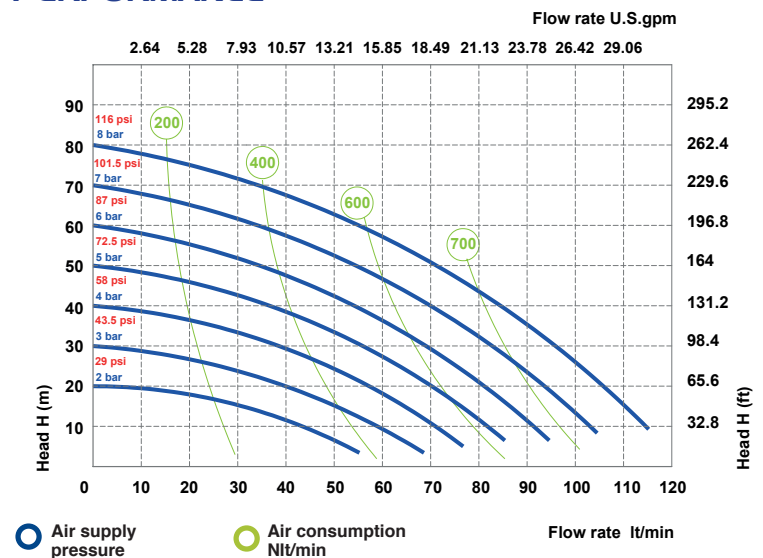

The curves and performance values refer to pumps with submerged suction and free delivery outlet, with water at 20°C. These data may vary according to the construction materials and hydraulic conditions.

DIMENSIONS

	A	B	C	Net Weight	Temperature
PP	293 mm	178 mm	280 mm	5,6 Kg	- 4°C + 65°C
PVDF	293 mm	178 mm	280 mm	7,6 Kg	- 20°C + 95°C
SS	258 mm	177 mm	295 mm	9,6 Kg	- 20°C + 95°C

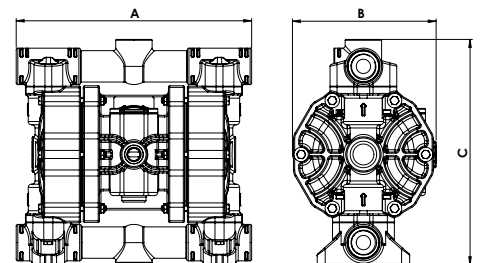

COMPOSITION

MODEL	CASING	DIAPHRAGM	BALLS	SEATS	GASKET	CONNECTIONS	ATEX	PORTS
P0120	P = PP	HT = HYTREL+PTFE	T = PTFE	P = PP	D = EPDM	1 = BSP		
	KC = PVDF+CF	MT = SANTOPRENE+PTFE	S = SS	K = PVDF	V = VITON	2 = FLANGED	- = zone 2	AB = STANDARD
	S = SS	H = HYTREL	D = EPDM	S = SS	N = NBR	5 = NPT		
		M = SANTOPRENE	N = NBR	Z = PE-UHMWE	T = PTFE			
		D = EPDM						
		N = NBR						

P 170



PP



PVDF+CF



ALU (P 160)

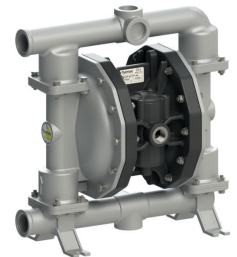

SS

TECHNICAL DATA

Fluid connections	1" BSP - DN25
Air connection	1/2" BSP
Max. Flow rate	170 lt/mm
Max air pressure	8 bar
Max delivery head	80 m
Max Suction Lift Dry	5 m
Max Suction Lift Wet	9,8 m
Max Solid passing	7,5 mm
Noise level:	75 dB
Max Viscosity:	35.000 cps
Displacement per Stroke:	700 CC ~

Ex II 3/3 G Ex h IIB T4 Gc
Ex II -/3 D Ex h IIIB T135°C Dc X

Displacement per stroke may vary based on suction condition, discharge head, air pressure and fluid type.

PERFORMANCE

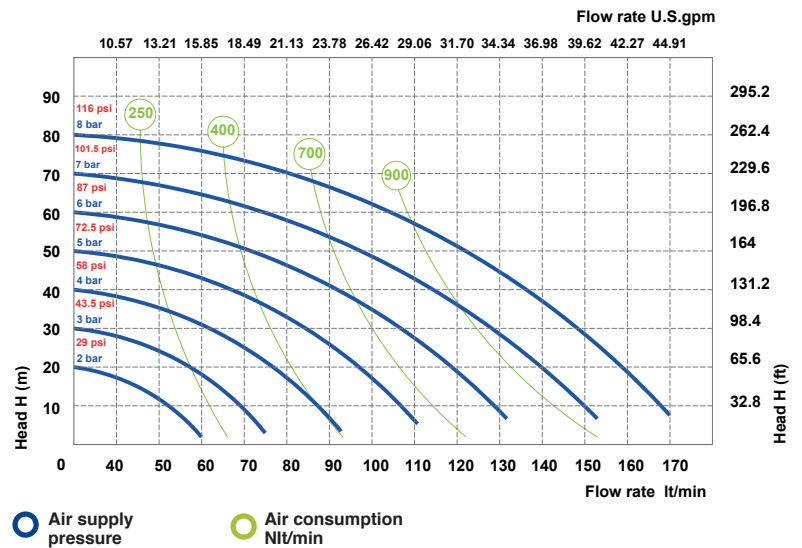

The curves and performance values refer to pumps with submerged suction and free delivery outlet, with water at 20°C. These data may vary according to the construction materials and hydraulic conditions.

DIMENSIONS

	A	B	C	Net Weight	Temperature
PP	430 mm	222 mm	416 mm	14,2 Kg	- 4°C + 65°C
PVDF	430 mm	222 mm	416 mm	16,2 Kg	- 20°C + 95°C
ALU	370 mm	222 mm	364 mm	13,2 Kg	- 20°C + 95°C
SS	357 mm	222 mm	371 mm	17,2 Kg	- 20°C + 95°C

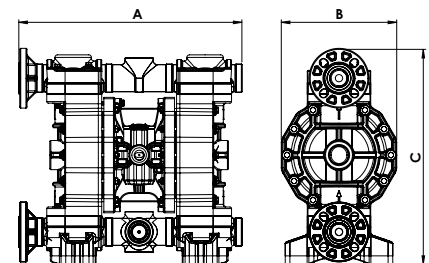

COMPOSITION

MODEL	CASING	DIAPHRAGM	BALLS	SEATS	GASKET	CONNECTIONS	ATEX	PORTS
P0170	P = PP	HT = HYTREL+PTFE	T = PTFE	P = PP	D = EPDM	1 = BSP		
P0160	KC = PVDF+CF	MT = SANTOPRENE+PTFE	S = SS	K = PVDF	V = VITON	2 = FLANGED	- = zone 2	AB = STANDARD
	S = SS	H = HYTREL	D = EPDM	S = SS	N = NBR	5 = NPT		
	A = ALU	M = SANTOPRENE	N = NBR	Z = PE-UHMWE	T = PTFE			
		D = EPDM		A = ALU				
		N = NBR						

P 252



PP



PVDF+CF



ALU (P 250)



SS

TECHNICAL DATA

Fluid connections	1"1/4" BSP
Air connection	1/2" BSP
Max. Flow rate	250 lt/min
Max air pressure	8 bar
Max delivery head	80 m
Max Suction Lift Dry	5 m
Max Suction Lift Wet	9,8 m
Max Solid passing	7,5 mm
Noise level:	75 dB
Max Viscosity:	35.000 cps
Displacement per Stroke:	700 CC ~

Ex II 3/3 G Ex h IIB T4 Gc
Ex II -/3 D Ex h III B T135°C Dc X

Displacement per stroke may vary based on suction condition, discharge head, air pressure and fluid type.

PERFORMANCE

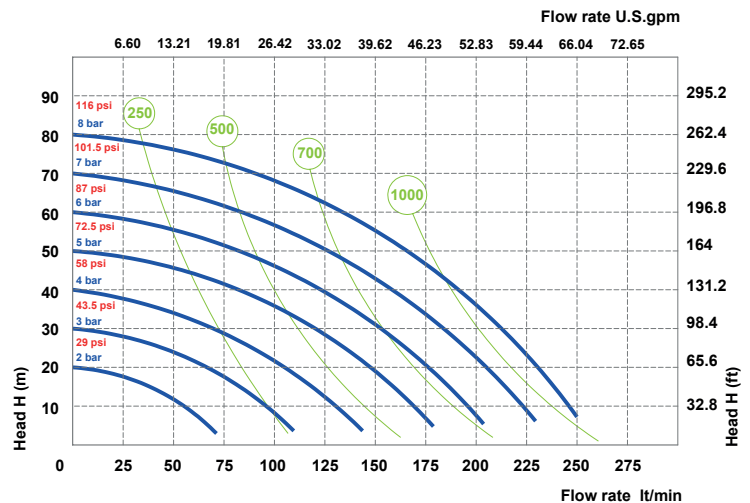

○ Air supply pressure ○ Air consumption Nlt/min

The curves and performance values refer to pumps with submerged suction and free delivery outlet, with water at 20°C. These data may vary according to the construction materials and hydraulic conditions.

DIMENSIONS

	A	B	C	Net Weight	Temperature
PP	396 mm	222 mm	388 mm	14,2 Kg	- 4°C + 65°C
PVDF	396 mm	222 mm	388 mm	16,2 Kg	- 20°C + 95°C
ALU	370 mm	222 mm	364 mm	13,2 Kg	- 20°C + 95°C
SS	357 mm	222 mm	374 mm	17,2 Kg	- 20°C + 95°C

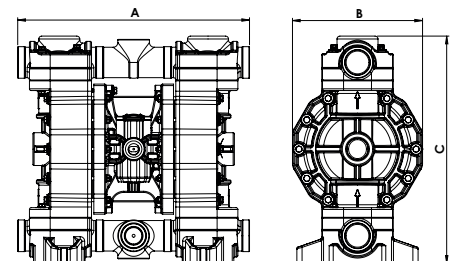

COMPOSITION

MODEL	CASING	DIAPHRAGM	BALLS	SEATS	GASKET	CONNECTIONS	ATEX	PORTS
P0252	P = PP	HT = HYTREL+PTFE	T = PTFE	P = PP	D = EPDM	1 = BSP		
P0250	KC = PVDF+CF	MT = SANTOPRENE+PTFE	S = SS	K = PVDF	V = VITON	2 = FLANGED	- = zone 2	AB = STANDARD
	S = SS	H = HYTREL	D = EPDM	S = SS	N = NBR	5 = NPT		
	A = ALU	M = SANTOPRENE	N = NBR	Z = PE-UHMWE	T = PTFE			
		D = EPDM		A = ALU				
		N = NBR						

P 400

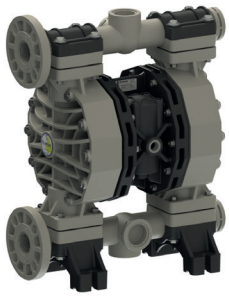

PP



PVDF+CF

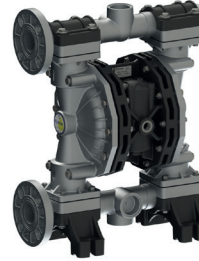

ALU



SS

TECHNICAL DATA

Fluid connections	1"1/2 BSP - DN 40
Air connection	1/2" BSP
Max. Flow rate	380 lt/min
Max air pressure	8 bar
Max delivery head	80 m
Max Suction Lift Dry	5 m
Max Suction Lift Wet	9,8 m
Max Solid passing	8 mm
Noise level:	78 dB
Max Viscosity:	40.000 cps
Displacement per Stroke:	1200 CC ~

Ex II 3/3 G Ex h IIB T4 Gc
Ex II -/3 D Ex h IIB T135°C Dc X

Displacement per stroke may vary based on suction condition, discharge head, air pressure and fluid type.

PERFORMANCE

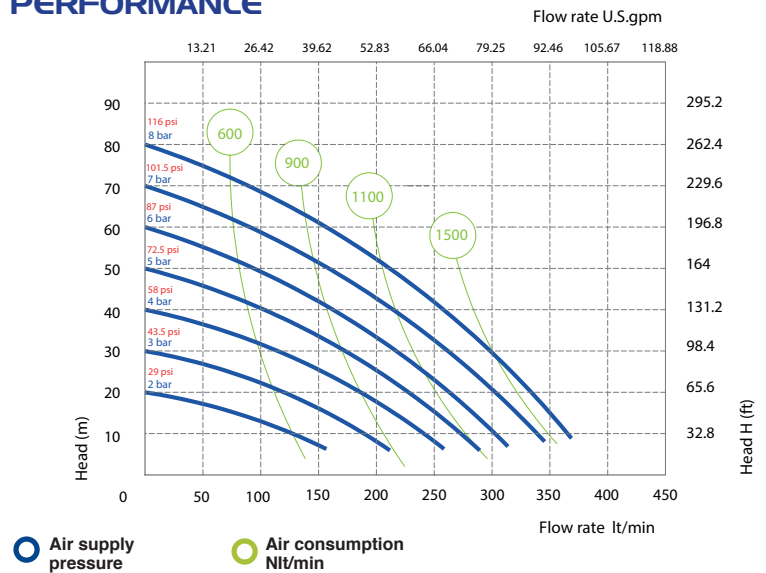

The curves and performance values refer to pumps with submerged suction and free delivery outlet, with water at 20°C. These data may vary according to the construction materials and hydraulic conditions.

DIMENSIONS

	A	B	C	Net Weight	Temperature
PP	454 mm	260 mm	564 mm	18,2 Kg	- 4°C + 65°C
PVDF	454 mm	260 mm	564 mm	22,2 Kg	- 20°C + 95°C
ALU	445 mm	260 mm	563 mm	22,2 Kg	- 20°C + 95°C
SS	361 mm	260 mm	502 mm	25,3 Kg	- 20°C + 95°C

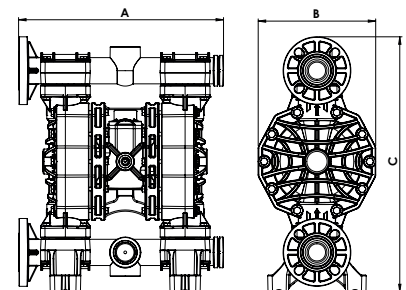

COMPOSITION

MODEL	CASING	DIAPHRAGM	BALLS	SEATS	GASKET	CONNECTIONS	ATEX	PORTS
P0400	P = PP	HT = HYTREL+PTFE	T = PTFE	P = PP	D = EPDM	1 = BSP	- = zone 2	AB = STANDARD EF = STANDARD SS
	KC = PVDF+CF	MT = SANTOPRENE+PTFE	S = SS	K = PVDF	V = VITON	2 = FLANGED		
	S = SS	H = HYTREL	D = EPDM	S = SS	N = NBR	5 = NPT		
	A = ALU	M = SANTOPRENE	N = NBR	Z = PE-UHMWE	T = PTFE			

P 700



PP



PVDF+CF

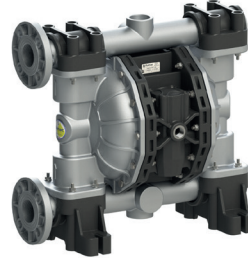

ALU

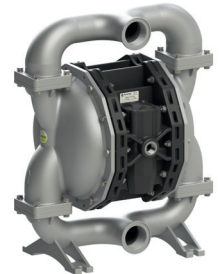

SS

TECHNICAL DATA

Fluid connections	2" BSP - DN 50
Air connection	3/4" BSP
Max. Flow rate	700 lt/min
Max air pressure	8 bar
Max delivery head	80 m
Max Suction Lift Dry	5 m
Max Suction Lift Wet	9,8 m
Max Solid passing	8,5 mm
Noise level:	78 dB
Max Viscosity:	50.000 cps
Displacement per Stroke:	3050 CC ~

Ex II 3/3 G Ex h IIB T4 Gc
Ex II -/3 D Ex h IIIB T135°C Dc X

Displacement per stroke may vary based on suction condition, discharge head, air pressure and fluid type.

PERFORMANCE

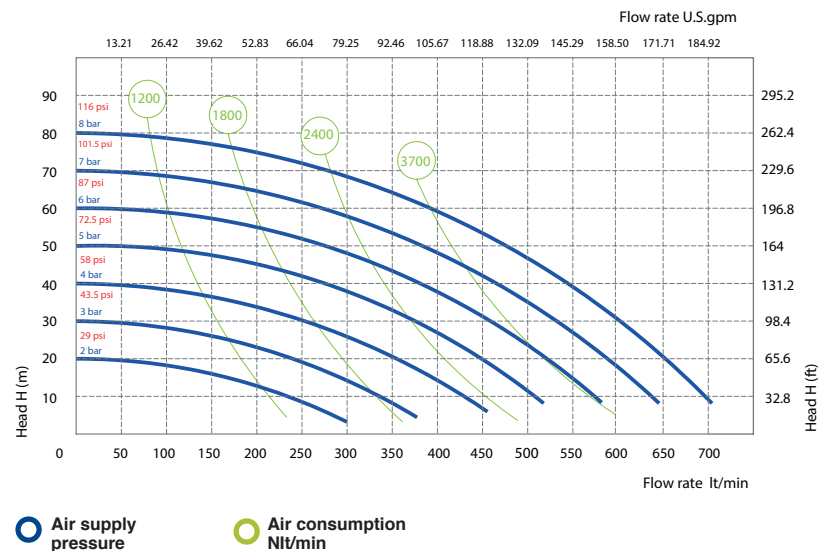

The curves and performance values refer to pumps with submerged suction and free delivery outlet, with water at 20°C. These data may vary according to the construction materials and hydraulic conditions.

DIMENSIONS

	A	B	C	Net Weight	Temperature
PP	595 mm	345 mm	570 mm	30,6 Kg	- 4°C + 65°C
PVDF	595 mm	345 mm	570 mm	41,6 Kg	- 20°C + 95°C
ALU	595 mm	345 mm	567 mm	37,6 Kg	- 20°C + 95°C
SS	487 mm	345 mm	599 mm	51 Kg	- 20°C + 95°C

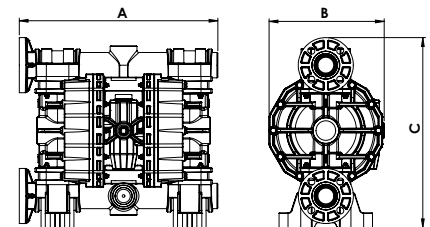

COMPOSITION

MODEL	CASING	DIAPHRAGM	BALLS	SEATS	GASKET	CONNECTIONS	ATEX	PORTS
P0700	P = PP	HT = HYTREL+PTFE	T = PTFE	P = PP	D = EPDM	1 = BSP	- = zone 2	AB = STANDARD
	KC = PVDF+CF	MT = SANTOPRENE+PTFE	S = SS	K = PVDF	V = VITON	2 = FLANGED		EF = STANDARD SS
	S = SS	H = HYTREL	D = EPDM	S = SS	N = NBR	5 = NPT		
	A = ALU	M = SANTOPRENE	N = NBR	Z = PE-UHMWE	T = PTFE			

P 1000



PP



PVDF



ALU



SS

TECHNICAL DATA

Fluid connections	3" BSP - DN 80
Air connection	3/4" BSP
Max. Flow rate	1050 lt/min
Max air pressure	8 bar
Max delivery head	80 m
Max Suction Lift Dry	5 m
Max Suction Lift Wet	9,8 m
Max Solid passing	12 mm
Noise level:	82 dB
Max Viscosity:	55.000 cps
Displacement per Stroke:	9750 CC ~

Ex II 3/3 G Ex h IIB T4 Gc
Ex II -/3 D Ex h IIB T135°C Dc X

Displacement per stroke may vary based on suction condition, discharge head, air pressure and fluid type.

PERFORMANCE

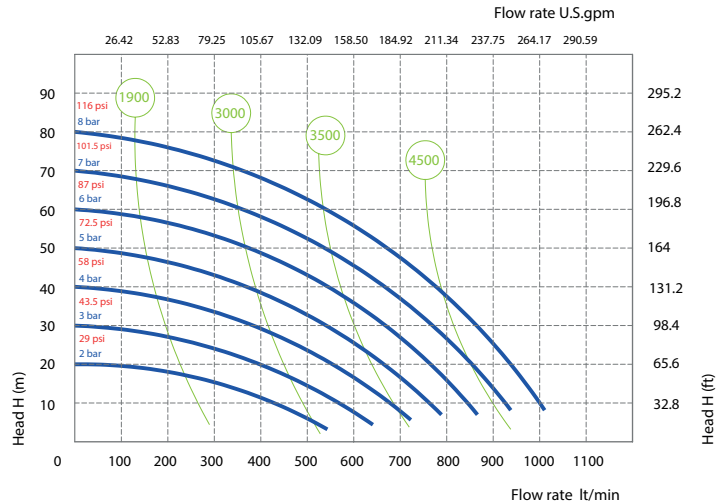

● Air supply pressure ● Air consumption Nl/min

The curves and performance values refer to pumps with submerged suction and free delivery outlet, with water at 20°C. These data may vary according to the construction materials and hydraulic conditions.

DIMENSIONS

	A	B	C	Net Weight	Temperature
PP	685 mm	417 mm	933 mm	48,5 Kg	- 4°C + 65°C
PVDF	685 mm	417 mm	933 mm	53,5 Kg	- 20°C + 95°C
ALU	570 mm	420 mm	838 mm	53,5 Kg	- 20°C + 95°C
SS	570 mm	420 mm	838 mm	111,5 Kg	- 20°C + 95°C

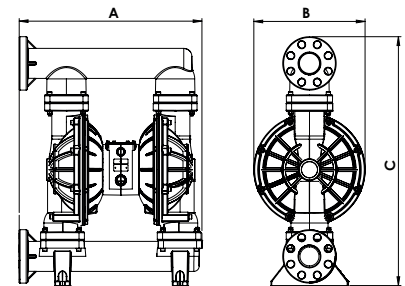

COMPOSITION

MODEL	CASING	DIAPHRAGM	BALLS	SEATS	GASKET	CONNECTIONS	ATEX	PORTS
P1000	P = PP	HT = HYTREL+PTFE	T = PTFE	P = PP	D = EPDM	1 = BSP 2 = FLANGED	- = zone 2	AB = STANDARD
	K = PVDF	MT = SANTOPRENE+PTFE	S = SS	K = PVDF	V = VITON			
	S = SS	H = HYTREL	D = EPDM	S = SS	N = NBR			
	A = ALU	M = SANTOPRENE	N = NBR	A = ALU	T = PTFE			



PHOENIX FOOD

Air operated double diaphragms pumps



Realized in:



SS AISI 316 electro-polished

Flow-rate from 20lt/min to 1.000 lt/min

Tri-Clamp Connection.

ATEX certification

Atex zone 2  II 3/3 G Ex h IIB T4 Gc
 II -/3 D Ex h IIIB T135°C Dc X

Atex zone I  II 2/2 G Ex h IIB T4 Gb
 II -/2 D Ex h IIIB T135°C Db X

PF 18



AISI 316 ELECTRO-POLISHED

- Fluid connections **3/4" TRI-CLAMP**
- Air connection **6 mm**
- Max. Flow rate **20 lt/min**
- Max air pressure **7 bar**
- Max delivery head **70 m**
- Max Suction Lift Dry **5 m**
- Max Suction Lift Wet **9,8 m**
- Max Solid passing **2,5 mm**
- Noise level: **65 dB**
- Max Viscosity: **10.000 cps**
- Displacement per Stroke: **30 CC ~**

ATEX ZONE 2 certification as Standard and, on request, **ATEX ZONE 1**.

Displacement per stroke may vary based on suction condition, discharge head, air pressure and fluid type.

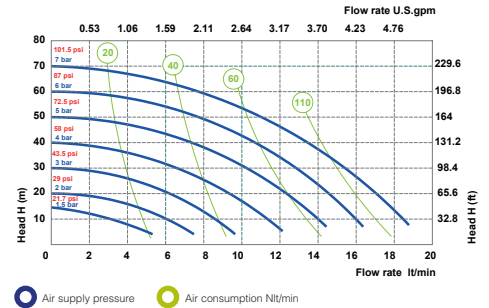
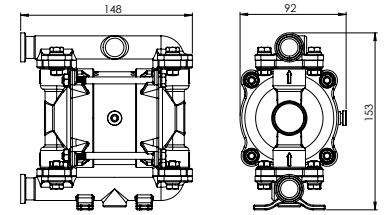

The curves and performance values refer to pumps with submerged suction and free delivery outlet, with water at 20°C. These data may vary according to the construction materials and hydraulic conditions.

Net Weight	Temperature
2,3 Kg	-20°C +95°C

MODEL	CASING	DIAPHRAGM	BALLS	SEATS	GASKET	CONNECTIONS	ATEX	PORTS
PF0018	S = SS POLISHED	HT = HYTREL+PTFE	T = PTFE S = SS	S = SS	T = PTFE	3 = TRI-CLAMP 1 = BSP 6 = DIN	- = zone 2 X = zone 1	AB = STANDARD

PF 30



AISI 316 ELECTRO-POLISHED

- Fluid connections **1" TRI-CLAMP**
- Air connection **6 mm**
- Max. Flow rate **35 lt/min**
- Max air pressure **7 bar**
- Max delivery head **70 m**
- Max Suction Lift Dry **5 m**
- Max Suction Lift Wet **9,8 m**
- Max Solid passing **3 mm**
- Noise level: **65 dB**
- Max Viscosity: **15.000 cps**
- Displacement per Stroke: **65 CC ~**

ATEX ZONE 2 certification as Standard and, on request, **ATEX ZONE 1**.

Displacement per stroke may vary based on suction condition, discharge head, air pressure and fluid type.

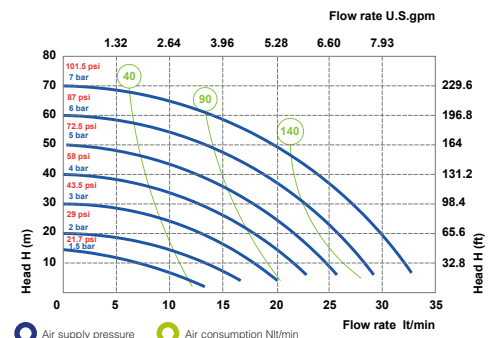
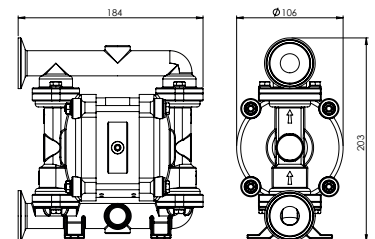

The curves and performance values refer to pumps with submerged suction and free delivery outlet, with water at 20°C. These data may vary according to the construction materials and hydraulic conditions.

Net Weight	Temperature
3,8 Kg	-20°C +95°C

MODEL	CASING	DIAPHRAGM	BALLS	SEATS	GASKET	CONNECTIONS	ATEX	PORTS
PF0030	S = SS POLISHED	HT = HYTREL+PTFE	T = PTFE S = SS	S = SS	T = PTFE	3 = TRI-CLAMP 1 = BSP 6 = DIN	- = zone 2 X = zone 1	AB = STANDARD

PF 60



AISI 316 ELECTRO-POLISHED

- Fluid connections **1" TRI-CLAMP**
- Air connection **1/4" BSP**
- Max. Flow rate **65 lt/min**
- Max air pressure **8 bar**
- Max delivery head **80 m**
- Max Suction Lift Dry **5 m**
- Max Suction Lift Wet **9,8 m**
- Max Solid passing **3,5 mm**
- Noise level: **72 dB**
- Max Viscosity: **20.000 cps**
- Displacement per Stroke: **140 CC ~**

Ex **ATEX ZONE 2** certification as Standard and, on request, **ATEX ZONE 1**.

Displacement per stroke may vary based on suction condition, discharge head, air pressure and fluid type.

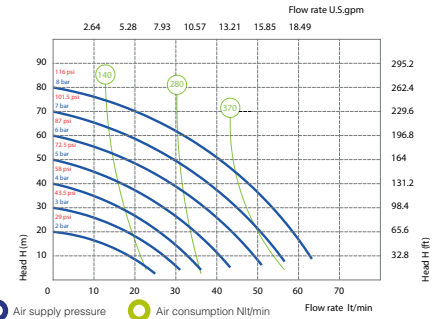
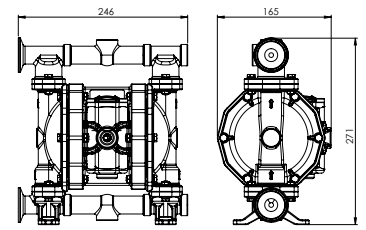

The curves and performance values refer to pumps with submerged suction and free delivery outlet, with water at 20°C. These data may vary according to the construction materials and hydraulic conditions.

Net Weight	Temperature
7,3 Kg	-20°C +95°C

MODEL	CASING	DIAPHRAGM	BALLS	SEATS	GASKET	CONNECTIONS	ATEX	PORTS
PF0060	S = SS POLISHED	HT = HYTREL+PTFE	T = PTFE S = SS	S = SS	T = PTFE	3 = TRI-CLAMP 1 = BSP 6 = DIN	- = zone 2 X = zone 1	AB = STANDARD

PF 120

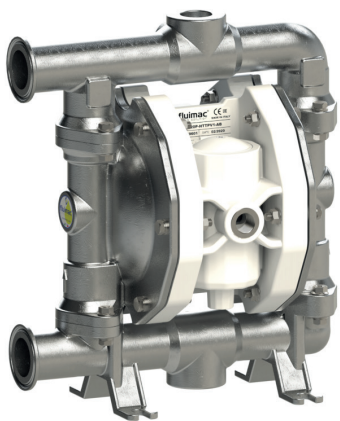

AISI 316 ELECTRO-POLISHED

- Fluid connections **1"1/2" TRI-CLAMP**
- Air connection **3/8" BSP**
- Max. Flow rate **120 lt/min**
- Max air pressure **8 bar**
- Max delivery head **80 m**
- Max Suction Lift Dry **5 m**
- Max Suction Lift Wet **9,8 m**
- Max Solid passing **4 mm**
- Noise level: **72 dB**
- Max Viscosity: **25.000 cps**
- Displacement per Stroke: **200 CC ~**

Ex **ATEX ZONE 2** certification as Standard and, on request, **ATEX ZONE 1**.

Displacement per stroke may vary based on suction condition, discharge head, air pressure and fluid type.

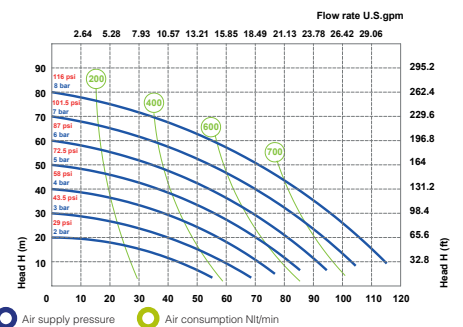
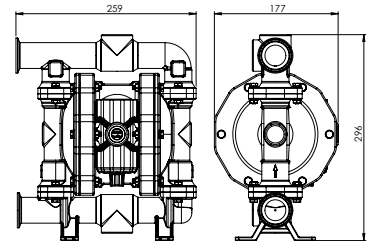

The curves and performance values refer to pumps with submerged suction and free delivery outlet, with water at 20°C. These data may vary according to the construction materials and hydraulic conditions.

Net Weight	Temperature
9,6 Kg	-20°C +95°C

MODEL	CASING	DIAPHRAGM	BALLS	SEATS	GASKET	CONNECTIONS	ATEX	PORTS
PF0120	S = SS POLISHED	HT = HYTREL+PTFE	T = PTFE S = SS	S = SS	T = PTFE	3 = TRI-CLAMP 1 = BSP 6 = DIN	- = zone 2 X = zone 1	AB = STANDARD

PF 170

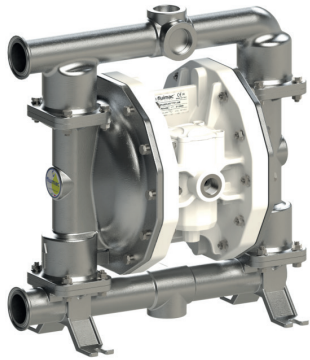

AISI 316 ELECTRO-POLISHED

- Fluid connections **1 1/2" TRI-CLAMP**
- Air connection **1/2" BSP**
- Max. Flow rate **170 lt/min**
- Max air pressure **8 bar**
- Max delivery head **80 m**
- Max Suction Lift Dry **5 m**
- Max Suction Lift Wet **9,8 m**
- Max Solid passing **7,5 mm**
- Noise level: **75 dB**
- Max Viscosity: **35.000 cps**
- Displacement per Stroke: **700 CC ~**

ATEX ZONE 2 certification as Standard and, on request, **ATEX ZONE 1**.

Displacement per stroke may vary based on suction condition, discharge head, air pressure and fluid type.

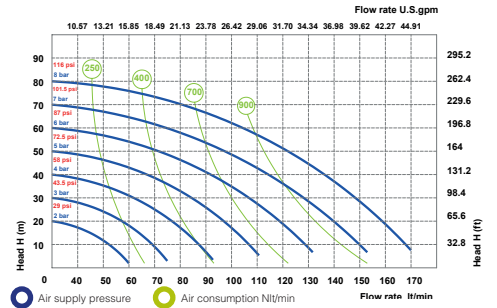
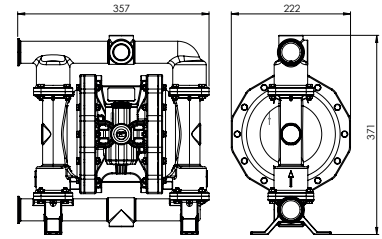

The curves and performance values refer to pumps with submerged suction and free delivery outlet, with water at 20°C. These data may vary according to the construction materials and hydraulic conditions.

Net Weight	Temperature
17,2 Kg	-20°C +95°C

MODEL	CASING	DIAPHRAGM	BALLS	SEATS	GASKET	CONNECTIONS	ATEX	PORTS
PF0170	S = SS POLISHED	HT =HYTREL+PTFE	T = PTFE S = SS	S = SS	T = PTFE	3 = TRI-CLAMP 1 = BSP 6 = DIN	- = zone 2 X = zone 1	AB = STANDARD

PHOENIX FOOD 400

TECHNICAL DATA

PERFORMANCE

PF 400



AISI 316 ELECTRO-POLISHED

- Fluid connections **2" TRI-CLAMP**
- Air connection **1/2" BSP**
- Max. Flow rate **380 lt/min**
- Max air pressure **8 bar**
- Max delivery head **80 m**
- Max Suction Lift Dry **5 m**
- Max Suction Lift Wet **9,8 m**
- Max Solid passing **8 mm**
- Noise level: **78 dB**
- Max Viscosity: **40.000 cps**
- Displacement per Stroke: **1200 CC ~**

ATEX ZONE 2 certification as Standard and, on request, **ATEX ZONE 1**.

Displacement per stroke may vary based on suction condition, discharge head, air pressure and fluid type.

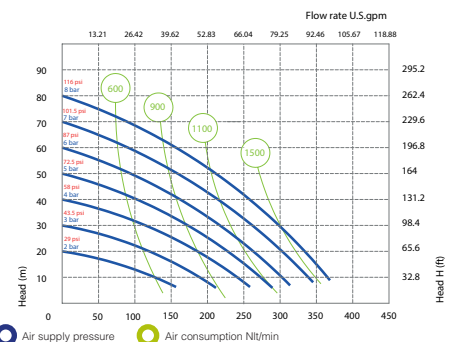
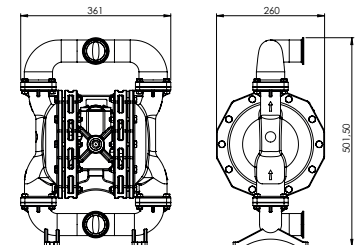

The curves and performance values refer to pumps with submerged suction and free delivery outlet, with water at 20°C. These data may vary according to the construction materials and hydraulic conditions.

Net Weight	Temperature
25,3 Kg	-20°C +95°C

MODEL	CASING	DIAPHRAGM	BALLS	SEATS	GASKET	CONNECTIONS	ATEX	PORTS
PF0400	S = SS POLISHED	HT = HYTREL+PTFE	T = PTFE S = SS	S = SS	T = PTFE	3 = TRI-CLAMP 1 = BSP 6 = DIN	- = zone 2 X = zone 1	EF = STANDARD

PF 700

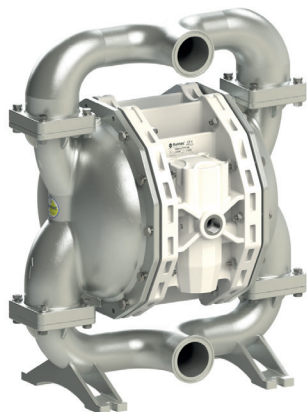

AISI 316 ELECTRO-POLISHED

- Fluid connections **2”1/2 TRI-CLAMP**
- Air connection **3/4” BSP**
- Max. Flow rate **700 lt/min**
- Max air pressure **8 bar**
- Max delivery head **80 m**
- Max Suction Lift Dry **5 m**
- Max Suction Lift Wet **9,8 m**
- Max Solid passing **8,5 mm**
- Noise level: **78 dB**
- Max Viscosity: **50.000 cps**
- Displacement per Stroke: **3050 CC ~**

Ex ATEX ZONE 2 certification as Standard and, on request, ATEX ZONE 1.

Displacement per stroke may vary based on suction condition, discharge head, air pressure and fluid type.

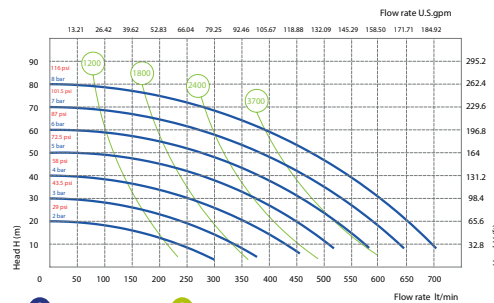
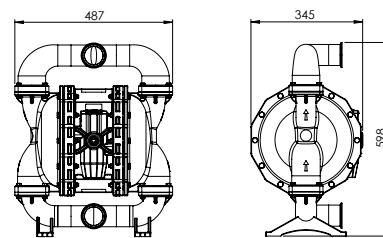

The curves and performance values refer to pumps with submerged suction and free delivery outlet, with water at 20°C. These data may vary according to the construction materials and hydraulic conditions.

Net Weight	Temperature
51 Kg	-20°C +95°C

MODEL	CASING	DIAPHRAGM	BALLS	SEATS	GASKET	CONNECTIONS	ATEX	PORTS
PF0700	S = SS POLISHED	HT = HYTREL+PTFE	T = PTFE S = SS	S = SS	T = PTFE	3 = TRI-CLAMP 1 = BSP 6 = DIN	- = zone 2 X = zone 1	EF = STANDARD

PF 1000



AISI 316 ELECTRO-POLISHED

- Fluid connections **3” BSP**
- Air connection **3/4” BSP**
- Max. Flow rate **1050 lt/min**
- Max air pressure **8 bar**
- Max delivery head **80 m**
- Max Suction Lift Dry **5 m**
- Max Suction Lift Wet **9,8 m**
- Max Solid passing **12 mm**
- Noise level: **82 dB**
- Max Viscosity: **55.000 cps**
- Displacement per Stroke: **9750 CC ~**

Ex ATEX ZONE 2 certification as Standard and, on request, ATEX ZONE 1.

Displacement per stroke may vary based on suction condition, discharge head, air pressure and fluid type.

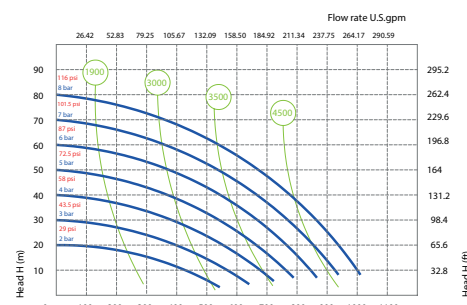
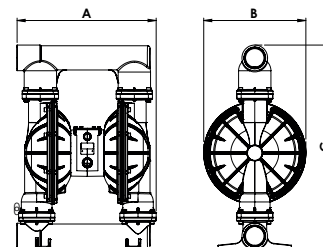

The curves and performance values refer to pumps with submerged suction and free delivery outlet, with water at 20°C. These data may vary according to the construction materials and hydraulic conditions.

Net Weight	Temperature
111,5 Kg	-20°C +95°C

MODEL	CASING	DIAPHRAGM	BALLS	SEATS	GASKET	CONNECTIONS	ATEX	PORTS
PF1000	S = SS POLISHED	HT = HYTREL+PTFE	T = PTFE S = SS	S = SS	T = PTFE	3 = TRI-CLAMP 1 = BSP 6 = DIN	- = zone 2 X = zone 1	AB = STANDARD



SPECIAL PUMPS

Air operated double diaphragms pumps
with special features:

PHOENIX ATEX certification zone I ATEX

ACCURATE PHOENIX remote control

DRUM PHOENIX to empty drums and tanks

TWIN PHOENIX with double inlet/outlet

POWDER PHOENIX to handle powder transferring

SUBMERSIBLE PHOENIX ready to be submerged directly into the fluid



POMc+CF



PP+CF



PVDF+CF



ALU



SS

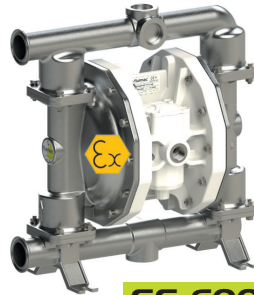

SS FOOD



European ATEX directive 2014/34/UE

II 2/2 G Ex h IIB T4 Gb

II -/2 D Ex h IIB T135°C Db X

Safety symbol in agreement with DIN 40012 appendix A

II 2/2 G surface equipment for use in zones with the occasional presence of combustible gases, fumes or fogs, as well as dust, in the air during the normal

II -/2 D operation (EN 1127-1 par. 6.3), in the external and internal zone.

Ex h equipment in protection mode "c", or "b", or "k", in agreement with standard EN 80079-37

IIB except for the following gases: hydrogen, acetylene, carbon sulphide

IIBB except for the following dust: conductive dust

T4/T135°C temperature class admitted.

PUMPS

ALL RANGE

MAIN APPLICATIONS

- Petrol-Chemical Industry
- Flexographic industry
- Food industry
- Painting industry
- Automotive industry

TECHNICAL DATA

Fluimac has filed with the BUREAU VERITAS certification body the documentation certifying ATEX compliance pursuant to Directive 2014/34/UE for its ranges of AODD pumps and pulsation dampeners, with special construction materials to have zone 1 certification.



ACCURATE PHOENIX

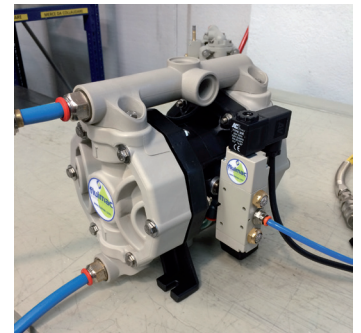
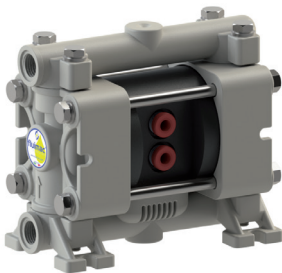
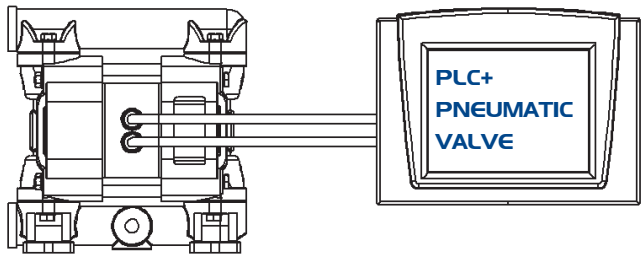
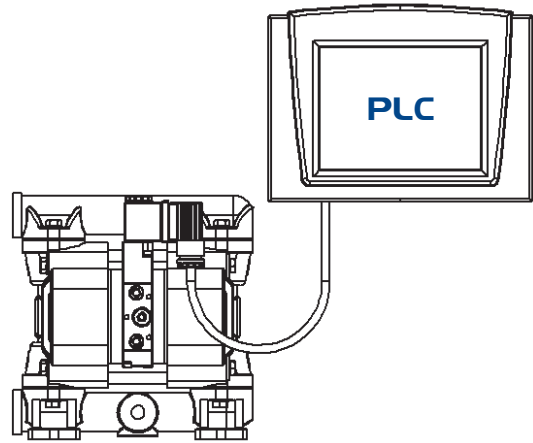

PUMPS

AP7
AP18
AP30
AP60

AP90
AP120
AP170
AP252

MAIN APPLICATIONS

- CHEMICAL INDUSTRY
- WASTE DISPOSAL TECHNOLOGY
- FLEXOGRAPHIC INDUSTRY
- PAINTING INDUSTRY
- PRINTING INDUSTRY
- WATER TREATMENT

TECHNICAL DATA

ACCURATE PHOENIX are Pumps that give you the external pump control necessary for exacting applications such as batching. Featuring a direct electrical interface that utilizes electrical impulses to stroke the pump instead of differential pressure, the ACCURATE PHOENIX provides a variable stroke rate that you can easily control as needed.

Note: PLC and computer system not included.

DRUM PHOENIX

PUMPS

DP18 - DP30 - DP60 - DP120 - DP170

MAIN APPLICATIONS

- CHEMICAL INDUSTRY
- WASTE DISPOSAL TECHNOLOGY
- AUTOMOTIVE INDUSTRY
- FOOD INDUSTRY



TECHNICAL DATA

DRUM PHOENIX are designed for emptying drums and containers, and provide an economical and wear resistant alternative to other pumping systems. In order to handle a wide range of fluids, DP pumps are available in all materials. The pump can be quickly and easily mounted on the drum with its feet. The drum will be completely emptied with a suction pipe.

SUBMERSIBLE PHOENIX

PUMPS

ALL RANGE

MAIN APPLICATIONS

- CHEMICAL INDUSTRY
- WASTE DISPOSAL TECHNOLOGY
- FOOD INDUSTRY
- PETROL-CHEMICAL INDUSTRY

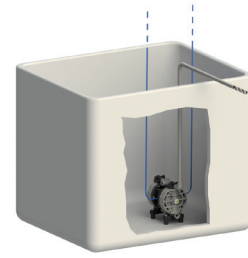

TECHNICAL DATA

SUBMERSIBLE pumps may be submerged into the liquid. It is important to make sure that all components which are in contact with the liquid are chemically compatible. The air exhaust must be led to the atmosphere by means of a hose.

TWIN PHOENIX

PUMPS

ALL RANGE

MAIN APPLICATIONS

- PAINTING INDUSTRY
- WASTEWATER TECHNOLOGY
- PRINTING INDUSTRY
- PAPER PROCESSING
- FLEXOGRAPHIC INDUSTRY

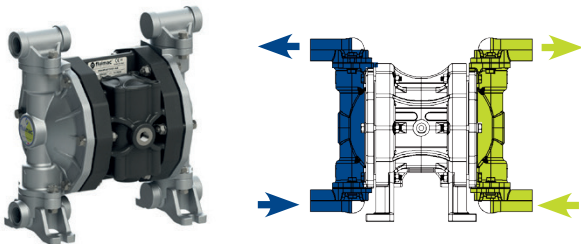

TECHNICAL DATA

TWIN PHOENIX are mainly used in the textile and paper processing industry. These dual action pumps are able to transfer two different media independently and simultaneously. This is accomplished by using separate connections on the suction and discharge ports, keeping two pumped media isolated from each other, preventing unwanted mixing.

POWDER PHOENIX

PUMPS

PP400 - PP700 IN ALU AND SS

MAIN APPLICATIONS

- PAINTING INDUSTRY
- WASTEWATER TECHNOLOGY
- PRINTING INDUSTRY
- FOOD INDUSTRY
- CHEMICAL INDUSTRY



TECHNICAL DATA

POWDER pumps are designed to move bulk powders more effectively throughout your process vs. other unsafe and labor intensive means. These heavy duty pumps will consistently transfer fine-grained, low-bulk density dry powders in a dust-free operation.



DAMPER

Pneumatic, automatic pulsation dampeners Realized in:
PP, PVDF, ALUMINIUM, SS AISI 316, POMc
Applicable to all size of pumps.
ATEX ZONE 2 AND ZONE 1 CERTIFICATION
Available also in FOOD version.





DAMPER

The active pulsation dampener is the most efficient way to remove pressure variations on the discharge of the pump. Flumac pulsation dampener works actively with compressed air, setting automatically the correct pressure to minimize the pulsations. Pulsation dampeners require minimum maintenance and are, subject to the requirements of the application, available in the same housing and diaphragm materials as the pump.

HOW IT WORKS

The pulsating flow of the discharge forces the diaphragm upwards where it is cushioned by the air in the chamber. The flexing of the diaphragm absorbs the pulsation giving a smooth flow.



Significant Pulsation Reduction with an average 70% - 80% pulsation reduction in high back pressure applications.

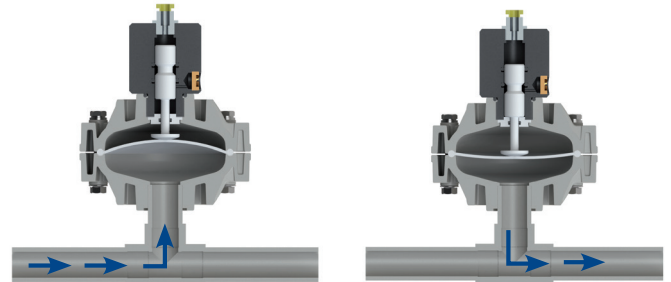

APPLICATION

- **METERING/INJECTION/DOSING:**
Equalizes discharge pressure spikes, increasing accuracy;
- **FILTER PRESS/INLINE FILTERS:**
Increases filter efficiency and life by providing a smooth flow;
- **SPRAYING:**
Smooth, consistent spray pattern;
- **FILLING:**
Eliminates inconsistent filling and splashing;
- **TRANSFER:**
Eliminates harmful water hammer, preventing pipe and valve damage.

INSTALLATION

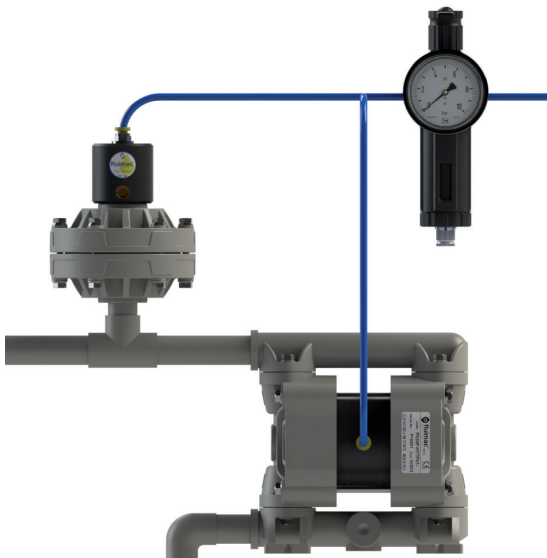

PORT POSITION

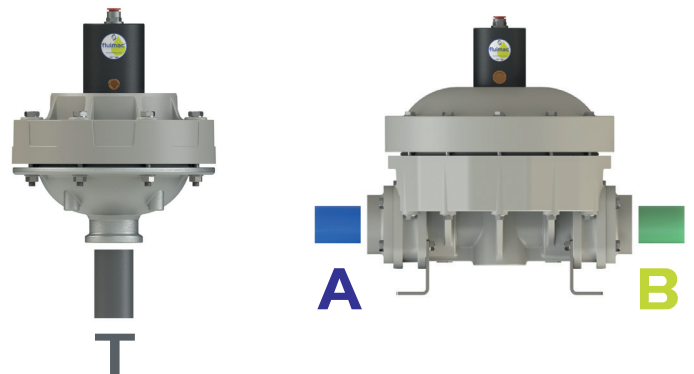

D20

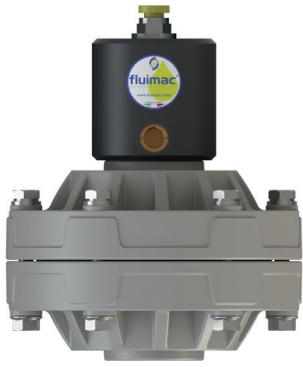

PP

Fluid connections **3/4" BSP**
 Air connection **6 mm**
 Max air pressure **7 bar**
 Capacity Volume **80 CC ~**

ATEX ZONE 2 certification as Standard and, on request, **ATEX ZONE 1**.

APPLY TO:
7 - 18 - 30



PVDF+CF



POMc

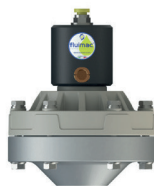

AISI

	PP	PVDF	POMc	AISI
A (mm)	119	119	119	119
B (mm)	143	143	143	143
Net Weight Kg	0,65	0,7	0,65	2
Max Temperature	+65°C	+95°C	+80°C	+95°C
Min Temperature	-4°C	-20°C	-5°C	-20°C

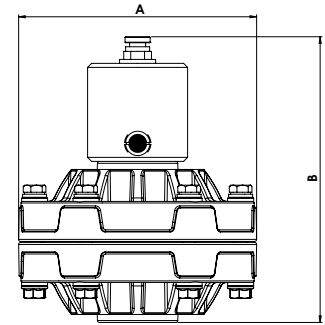

MODEL	CASING	DIAPHRAGM	CONNECTIONS	PORTS
D020	P = PP KC = PVDF+CF O = POMc S = SS	HT = HYTREL+PTFE MT = SANTOPRENE+PTFE H = HYTREL M = SANTOPRENE	1 = BSP 2 = FLANGE 5 = NPT	T = STANDARD

D25



PP

Fluid connections **1" BSP**
 Air connection **8 mm**
 Max air pressure **8 bar**
 Capacity Volume **200 CC ~**

ATEX ZONE 2 certification as Standard and, on request, **ATEX ZONE 1**.

APPLY TO:
55 - 60 - 90 - 120

	PP	PVDF	POMc	AISI
A (mm)	181	181	181	181
B (mm)	195	195	195	182
Net Weight Kg	1,75	2	1,9	6,7
Max Temperature	+65°C	+95°C	+80°C	+95°C
Min Temperature	-4°C	-20°C	-5°C	-20°C

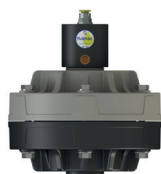
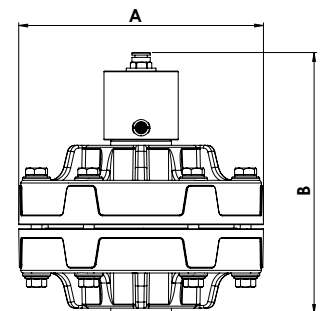

PVDF+CF



POMc

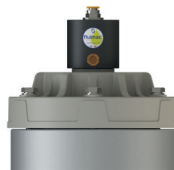

AISI

MODEL	CASING	DIAPHRAGM	CONNECTIONS	PORTS
D025	P = PP KC = PVDF+CF O = POMc S = SS	HT = HYTREL+PTFE MT = SANTOPRENE+PTFE H = HYTREL M = SANTOPRENE D = EPDM N = NBR	1 = BSP 2 = FLANGE 5 = NPT	T = STANDARD AB = SS

D40



PP

Fluid connections **1"1/2 BSP**
 Air connection **10 mm**
 Max air pressure **8 bar**
 Capacity Volume **700 CC ~**

ATEX ZONE 2 certification as Standard and, on request, **ATEX ZONE 1**.

APPLY TO:
 170 - 252 - 400

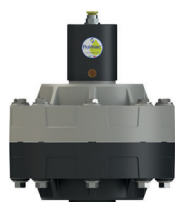

PVDF+CF



POMc

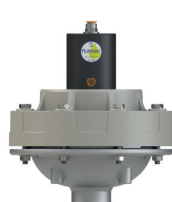

AISI

MODEL	CASING	DIAPHRAGM	CONNECTIONS	PORTS
D040	P = PP KC = PVDF+CF O = POMc S = SS	HT = HYTREL+PTFE MT = SANTOPRENE+PTFE H = HYTREL M = SANTOPRENE	1 = BSP 2 = FLANGE 5 = NPT	T = STANDARD

	PP	PVDF	POMc	AISI
A (mm)	231	231	231	231
B (mm)	270	270	270	267
Net Weight Kg	4	4,6	4,2	5,6
Max Temperature	+65°C	+95°C	+80°C	+95°C
Min Temperature	-4°C	-20°C	-5°C	-20°C

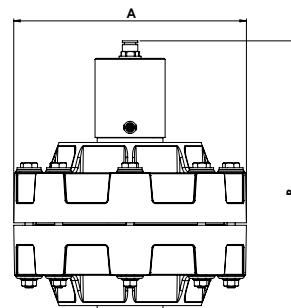

D50



PP

Fluid connections **2" BSP**
 Air connection **12 mm**
 Max air pressure **8 bar**
 Capacity Volume **2900 CC ~**

ATEX ZONE 2 certification as Standard and, on request, **ATEX ZONE 1**.

APPLY TO:
 700 - 1000



PVDF+CF



ALU



AISI

MODEL	CASING	DIAPHRAGM	O-RING	CONNECTIONS	PORTS
D050	P = PP KC = PVDF+CF A = ALU S = SS	HT = HYTREL+PTFE MT = SANTOPRENE+PTFE H = HYTREL M = SANTOPRENE D = EPDM N = NBR	D = EPDM V = VITON N = NBR T = PTFE	1 = BSP 2 = FLANGE 5 = NPT	AB = STANDARD

	PP	PVDF	ALU	AISI
A (mm)	404	404	400	402
B (mm)	425	425	425	408
Net Weight Kg	14	17	14,5	21,6
Max Temperature	+65°C	+95°C	+80°C	+95°C
Min Temperature	-4°C	-20°C	-5°C	-20°C

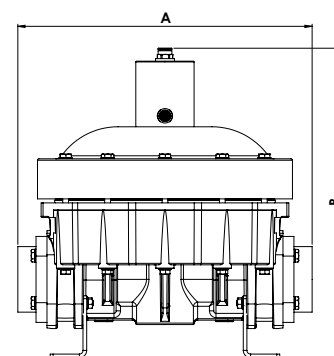



ACCESSORIES



AIR REGULATION KIT

Adjust and set air pressure and airflow-rate with a filter regulator, pressure gauge and air valve unit.



INOX TROLLEY

It makes pumps transportable.

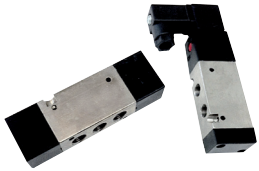

SWITCH VALVES

Remotely start and stop with a solenoid or pneumatic valve for the pump's air line.



ANTI VIBRATION FEET KIT

Reduces physical vibration from AODD pump operation.



STROKE COUNTER

Count the number of strokes, connected to a control. It allows various type of monitoring.



PP, PVDF, ALU SS NOOZLE

Dispenser to delivery control and batching.



DIAPHRAGM FAILURE DETECTION FLUID-GUARD

The Leak Detector provide a signal and the pump can be shut down when diaphragms fail.



REINFORCED PVC HOSE

With metal reinforcement for suction/discharge, also food-grade.



PNEUMATIC BATCH CONTROL

Pneumatic batcher can control any FLUIMAC AODD pump allowing you to set the cycles amount and count the strokes.

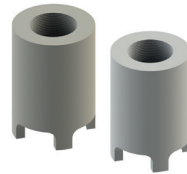

FOOT BALL VALVE

Realized in PP and PVDF. Size available 1" - 1"1/4 - 1"1/2 - 2" Used to prevent the suction hose from emptying.



ELECTRONIC BATCH CONTROL

Electronic batcher can control any FLUIMAC AODD pump allowing you to set the cycles amount and count the strokes.



SOFT STARTER

It is always recommended to start up an AODD pump slowly. This to protect the diaphragms.



BASKET STRAINER FILTERS IN PP

Installed on the suction of the pumps, protects them from suspended solids and impurity.



VALVES FITTINGS AND CONNECTIONS IN PP, PVC, INOX

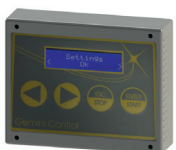

GEMINI CONTROL

Electronic Control System for accurate pumps. This system allows you to use AODD pump as dosing system.



FLANGE CONNECTION KIT

It modifies a pump with BSP connection into a flanged pump.



PRESSURE BOOSTER

Where the line pressure is not enough, this system doubles the in let pressure to supply correctly the air to the pump.



WALL FIXING BRACKET

Wall fixing bracket for diaphragm pumps, for all sizes.

fluimac[®]

pump solution



FLUIMAC S.r.l.

Via Ticino 2 / 4
21043, Castiglione Olona (VA) - Italy
Tel.:+39 0331 866688
Fax:+39 0331 864870

www.fluimac.com
info@fluimac.com

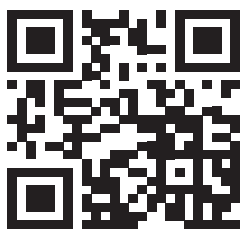

AUTHORIZED PARTNER:

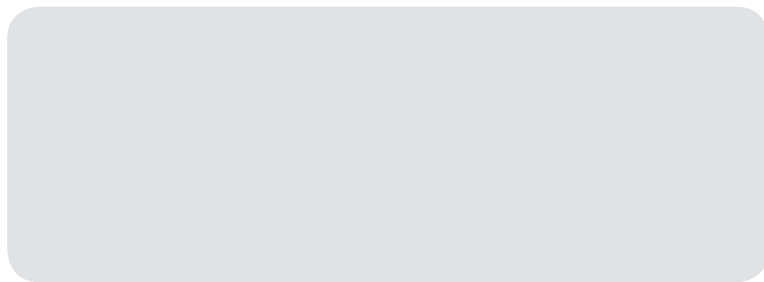

*Made in
Italy*

